

ESSER IQ8L-W

by Honeywell



EN54-23 Fire Alarm Devices
Visual Alarm Device for use
in & around buildings

Dispositifs incendie EN54-23
Dispositifs Visuels Alarme Feu pour utilisation
à l'intérieur et autour des bâtiments

EN54-23 Feuermeldevorrichtung
Optischer Signalgeber zur Innen-
und Aussenmontage

(13)



0333

DOP No.: 075441130625

No.d'identification NF: #####

Conforme au référentiel de certification NF-système de sécurité incendie
www.Marque-NF.com



9-60VDC



1.5W (max)



2.4m (max)



	High Power		Low Power	
	1 Hz	0.5Hz	1 Hz	0.5Hz
W-2.4-7.5	7.5m (135m³)		2.5m (15m³)	



	W-2.4-7.5		W-2.4-2.5	
	7.5m (135m³)	2.5m (15m³)	7.5m (135m³)	2.5m (15m³)
White Flash Flash Blanc Weisser Blitz	12V 51mA	27mA	35mA	19mA
	24V 25mA	16mA	16mA	10mA
	48V 18mA	11mA	11mA	9mA
Red Flash Flash Rouge Roter Blitz	12V 51mA	27mA	35mA	19mA
	24V 25mA	16mA	16mA	10mA
	48V 18mA	11mA	11mA	9mA



White Flash Flash Blanc Weisser Blitz	12V 51mA	27mA	35mA	19mA
	24V 25mA	16mA	16mA	10mA
	48V 18mA	11mA	11mA	9mA
Red Flash Flash Rouge Roter Blitz	12V 51mA	27mA	35mA	19mA
	24V 25mA	16mA	16mA	10mA
	48V 18mA	11mA	11mA	9mA



White Flash Flash Blanc Weisser Blitz	12V 51mA	27mA	35mA	19mA
	24V 25mA	16mA	16mA	10mA
	48V 18mA	11mA	11mA	9mA
Red Flash Flash Rouge Roter Blitz	12V 51mA	27mA	35mA	19mA
	24V 25mA	16mA	16mA	10mA
	48V 18mA	11mA	11mA	9mA



White Flash Flash Blanc Weisser Blitz	12V 51mA	27mA	35mA	19mA
	24V 25mA	16mA	16mA	10mA
	48V 18mA	11mA	11mA	9mA
Red Flash Flash Rouge Roter Blitz	12V 51mA	27mA	35mA	19mA
	24V 25mA	16mA	16mA	10mA
	48V 18mA	11mA	11mA	9mA



< 120% for 10mS



100mS ON / 900mS OFF
50mS ON / 950mS OFF



0.5mm² - 2.5mm²



-25°C ~ 70°C



FR ABS & Polycarbonate



Type A & B
S IP33C

Type B
D IP65 U IP65

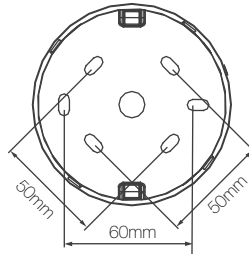
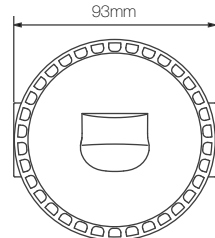

U & DEEP BASE
Embase U & Haute
U & Tiefer Socket

66mm

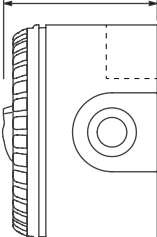

26-50 / 26-52

SHALLOW BASE
Embase basse
Flacher Socket

38mm

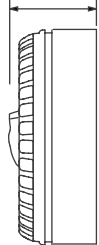

26-51



- Screws are not supplied
- Vis non fournies
- Schrauben sind nicht beigelegt

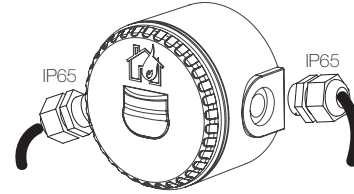
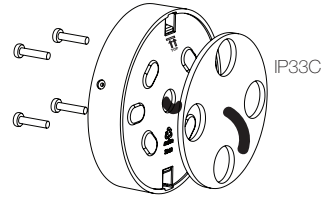

- Drilling diameter must be adjusted to the diameter of the cable glands.
- Le diamètre de perçage doit être adapté au diamètre des presse-étapes.
- Bohrdurchmesser muss dem Kabeldurchmesser angepasst sein.

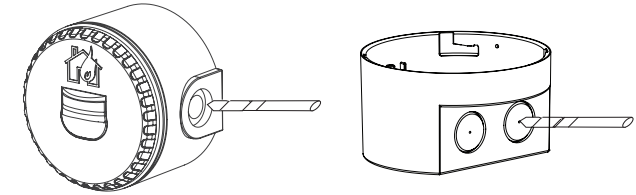

- Cable Glands must be compatible with declared cable size.
- Les presses-étoupes doivent être adaptés à la section des câbles déclarée
- Kabeldurchfuehrungen muessen mit den angegebenen Kabelabmessungen kompatibel sein

- Please use a gasket on both sides.
- Un joint torique doit être utilisé de chaque côté.
- An jeder Seite muss ein Dichtungsring angebracht werden.

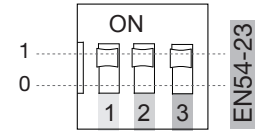
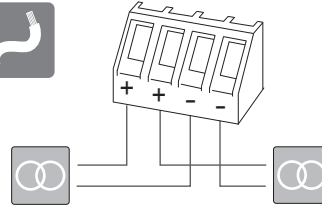
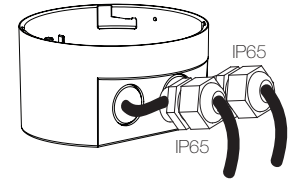

⚡	1Hz	1	PASS
	0.5Hz	0	PASS
P	High Power	1	PASS
	Low Power	0	PASS
R/B	N/A	0	PASS



Wall Mounted: W-2.4-7.5
Mural: W-2.4-7.5

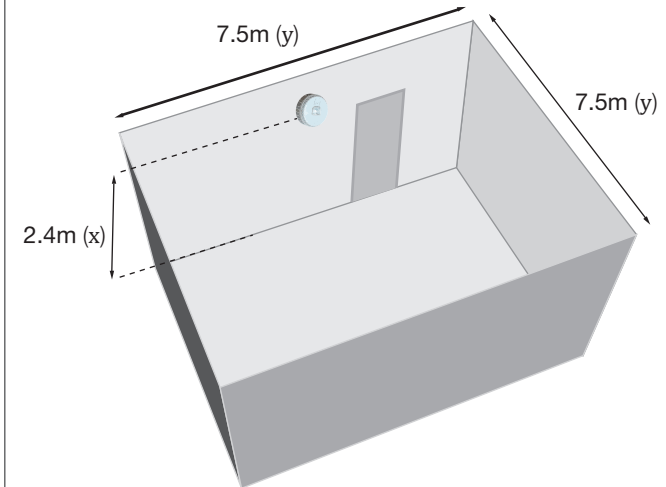

25-12724-A

ESSER by Honeywell

Isle d'Abeau - Parc de Chesnes - 8, Place de l'Europe - BP 7401
38074 SAINT QUENTIN FALLAVIER Cedex - France

Tél. : + 33 (0)8 10 10 66 10

Lieu de fabrication : Gwent NP44 3AW - UK

En raison de l'évolution des normes et du matériel, les caractéristiques indiquées par le texte et les images de ce document ne nous engagent qu'après confirmation par nos services.

Réf. : 03/14

Essential Characteristics / Caractéristiques

Operational Reliability / Fiabilité de Fonctionnement

Duration of operation / Durée de fonctionnement	PASS/CONFORME
Provision for external conductors / Disposition pour conducteurs extérieurs	PASS/CONFORME
Flammability of materials / Inflammabilité des matériaux	PASS/CONFORME
Enclosure protection / Indice de protection	PASS/CONFORME
Access / Accès	PASS/CONFORME
Manufacturer's adjustments / Réglages du fabricant	PASS/CONFORME
On-site adjustment of behaviour / Réglages du site	PASS/CONFORME
Requirements for software controlled devices / Exigences relatives aux dispositifs contrôlés par logiciel	PASS/CONFORME

Performance parameters under fire condition / Paramètres de performance en cas d'incendie

Coverage Volume / Volume de couverture	PASS/CONFORME
Variation of light output / Variance de la puissance lumineuse	PASS/CONFORME
Minimum/maximum light intensity / Intensité lumineuse minimale/maximale	PASS/CONFORME
Light colour / Couleur de la lumière	WHITE/RED / BLANC/ROUGE
Light pattern & frequency of flashing / Effets temporels lumineux et fréquence de clignotement du flash	0.5/1Hz
Marking & Data / Marquage et données techniques	PASS/CONFORME
Synchronisation	PASS/CONFORME

Temperature Resistance / Résistance à la température

Dry heat (operational) / Chaleur sèche (fonctionnel)	PASS/CONFORME
Dry heat (endurance) / Chaleur sèche (endurance)	PASS/CONFORME
Cold (operational) / Froid (fonctionnel)	PASS/CONFORME

Humidity Resistance / Résistance à l'humidité

Damp heat, cyclic (operational) / Chaleur humide, cyclique (fonctionnel)	PASS/CONFORME
Damp heat, steady state (endurance) / Chaleur humide, continue (endurance)	PASS/CONFORME
Damp heat, cyclic (endurance) / Chaleur humide, cyclique (endurance)	PASS/CONFORME

Shock & Vibration & Resistance / Choc & Vibration & Resistance

Shock (operational) / Choc mécanique (fonctionnel)	PASS/CONFORME
Impact (operational) / Impact (fonctionnel)	PASS/CONFORME
Vibration (operational) / Vibration (fonctionnel)	PASS/CONFORME
Vibration (endurance)	PASS/CONFORME

Corrosion Resistance / Résistance à la corrosion

SO ₂ corrosion (endurance) / Corrosion par le SO ₂	PASS/CONFORME
--------------------------------------------------------------------------	---------------

Electrical Stability / Stabilité électrique

EMC immunity (operational) / CEM Immunité (fonctionnel)	PASS/CONFORME
---------------------------------------------------------	---------------



Synchronisation Synchronisierung

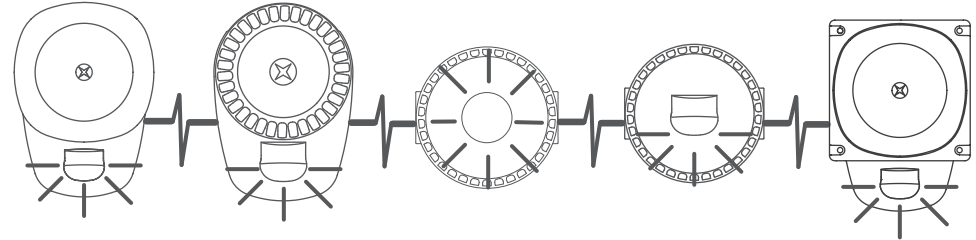

ESSER by Honeywell

Isle d'Abeau - Parc de Chesnes - 8, Place de l'Europe - BP 7401
38074 SAINT QUENTIN FALLAVIER Cedex - France
Tél. : + 33 (0)8 10 10 66 10

Lieu de fabrication : Gwent NP44 3AW - UK

25-12724-A

En raison de l'évolution des normes et du matériel, les caractéristiques indiquées par le texte et les images de ce document ne nous engagent qu'après confirmation par nos services.

Réf. : 03/14